

Section J-3: Miscellaneous Hardware

Miscellaneous Hardware

Section J-3: Miscellaneous Hardware

Maverick Hardware

Railing Hardware

Solid Brass & Stainless Steel Fittings and Components



Solid brass and stainless steel fittings and components for rail systems, public guidance railing, and hospitality fixtures. Always consult local building codes for spacing and bracket replacement requirements. All measurements shown are measured in inches. Different finishes available. All fittings sold per each, and are supplied with the necessary hardware for installation.

Handrail System

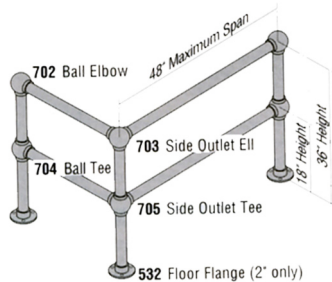

Footrail System

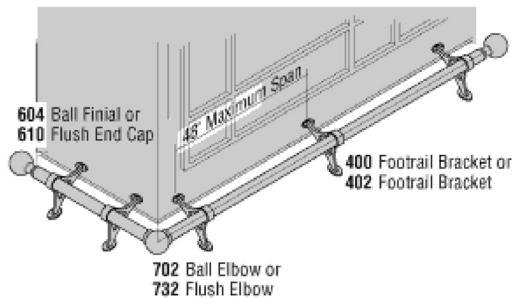

Brass & Satin Stainless Steel Round Tube

Sold per length.

| Part # | O.D. | Length | Finish |
|------------------|--------|---------|-----------------|
| LVA110/112-06-SS | 1 1/2" | 6 feet | Stainless Steel |
| LVA110/112-12 | 1 1/2" | 12 feet | Brass |
| LVA110/112-12-SS | 1 1/2" | 12 feet | Stainless Steel |
| LVA120/2-06-SS | 2" | 6 feet | Stainless Steel |
| LVA120/2-08 | 2" | 8 feet | Brass |
| LVA120/2-08-SS | 2" | 8 feet | Stainless Steel |
| LVA120/2-12 | 2" | 12 feet | Brass |
| LVA120/2-12-SS | 2" | 12 feet | Stainless Steel |

Standard Handrail Bracket



| Part # | CP | B | Finish |
|-------------|--------|--------|-----------------|
| LV301/112 | 2 1/2" | 2 1/2" | Brass |
| LV301/112SS | 2 1/2" | 2 1/2" | Satin Stainless |
| LV301/2 | 2 1/2" | 2 1/2" | Brass |
| LV301/2-SS | 2 1/2" | 2 1/2" | Satin Stainless |

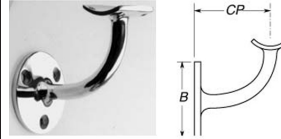

Flat Handrail Bracket

| Part # | CP | B | Finish |
|--------|--------|--------|--------|
| LV310 | 2 1/2" | 2 3/8" | Brass |



Armrail Bracket

| Part # | CP | Finish |
|---------|--------|--------|
| LV450/2 | 5 5/8" | Brass |

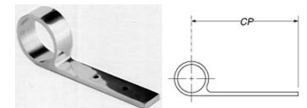

Flush End Post

| Part # | CP | B | Finish |
|--------------|---------|---------|-----------------|
| LV340/112 | 2 7/16" | 2 5/16" | Brass |
| LV340/112SSS | 2 7/16" | 2 5/16" | Satin Stainless |
| LV340/2 | 3 1/4" | 2 1/2" | Brass |
| LV340/2SSS | 3 1/4" | 2 1/2" | Satin Stainless |

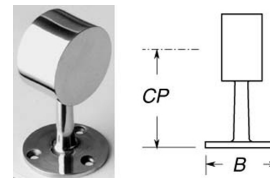

Saddle Post

| Part # | CP | B | Finish |
|-----------|---------|--------|--------|
| LV341/112 | 2 7/16" | 2 1/4" | Brass |
| LV341/2 | 3 1/4" | 2 1/2" | Brass |

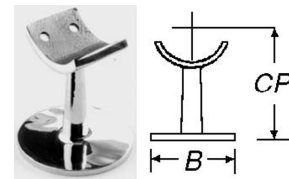

Flush Center Post

| Part # | CP | B | Finish |
|-----------|---------|---------|--------|
| LV342/112 | 2 7/16" | 2 5/16" | Brass |
| LV342/2 | 3 1/4" | 2 1/2" | Brass |

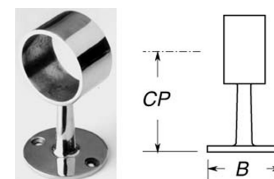

Description Codes:

| | | | |
|----|------------------------|---|----------------|
| CP | Centerline Projection | B | Base |
| D | Overall Diameter | H | Overall Height |
| P | Overall Projection | W | Width |
| SS | Satin 'Stainless Steel | | |

Railing Hardware



Combination Bracket

| Part # | CP | H | Finish |
|--------------|--------|--------|-----------------|
| LV400/112 | 6 1/8" | 6 1/4" | Brass |
| LV400/112-SS | 6 1/8" | 6 1/4" | Stainless Steel |
| LV400/2 | 6 1/8" | 6 1/2" | Brass |
| LV400/2-SS | 6 1/8" | 6 1/2" | Stainless Steel |

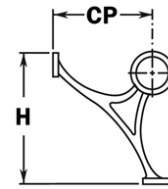

Bar Mount Bracket

| Part # | CP | B | Finish |
|------------|--------|--------|-----------------|
| LV402/112 | 6 1/6" | 4" | Brass |
| LV402/2 | 6 7/8" | 4 1/4" | Brass |
| LV402/2-SS | 6 7/8" | 4 1/4" | Stainless Steel |

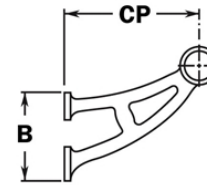

Floor Bracket

| Part # | H | B | Finish |
|------------|--------|----------|-----------------|
| LV404/112 | 5 5/8" | 6 11/16" | Brass |
| LV404/2 | 6 1/8" | 6 11/16" | Brass |
| LV404/2-SS | 6 1/8" | 6 11/16" | Stainless Steel |

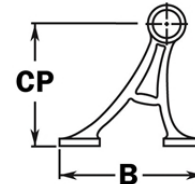

Victorian Bracket

| Part # | CP | B | Finish |
|---------|--------|----------|--------|
| LV410/2 | 8 1/8" | 4 11/16" | Brass |

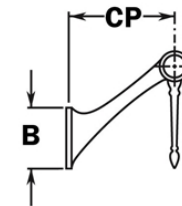

Solid Brass & Stainless Steel

Fittings and Components For Rail Systems



All fittings sold per each and are supplied with the necessary hardware for installation.

D Overall Diameter **H** Overall Height

Wall Flange

| Part # | D | H | Finish |
|-------------|----|---------|-----------------|
| LV510/112SS | 3" | 1 1/16" | Stainless Steel |
| LV530/2 | 4" | 1 1/16" | Brass |
| LV530/2-SS | 4" | 1 1/4" | Stainless Steel |



Floor Flange

| Part # | D | H | Finish |
|------------|----|--------|-----------------|
| LV512/112 | 4" | 1 1/4" | Brass |
| LV532/2 | 5" | 1 3/8" | Brass |
| LV532/2-SS | 5" | 1 3/8" | Stainless Steel |



Socket Flange

| Part # | D | H | Finish |
|-----------|--------|--------|--------|
| LV582/112 | 1 5/8" | 1 7/8" | Brass |



Flush Flange

| Part # | D | H | Finish |
|-------------|--------|------|-----------------|
| LV600/112SS | 1 1/2" | 1/8" | Stainless Steel |
| LV600/2 | 2" | 1/8" | Brass |
| LV600/2-SS | 2" | 1/8" | Stainless Steel |



Maverick Hardware

Railing Hardware



Ball Finial

| Part # | D | H | Finish |
|------------|--------|--------|-----------------|
| LV604/2 | 3 1/8" | 4 1/2" | Brass |
| LV604/2-SS | 3 1/8" | 4 1/2" | Stainless Steel |

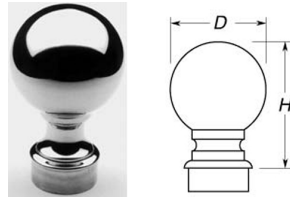

Scroll Finial

| Part # | W | H | Finish |
|-----------|--------|--------|--------|
| LV606/112 | 2 3/4" | 2 7/8" | Brass |
| LV606/2 | 3" | 3 1/4" | Brass |

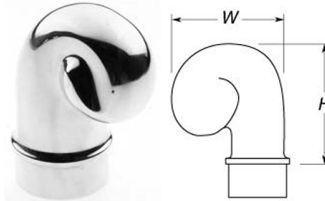

Ball Ell

| Part # | D | L | Finish |
|-------------|--------|--------|-----------------|
| LV702/112 | 2 1/2" | 2 3/4" | Brass |
| LV702/112SS | 2 1/2" | 2 3/4" | Stainless Steel |
| LV702/2 | 3 1/4" | 3 3/4" | Brass |
| LV702/2-SS | 3 1/4" | 3 3/4" | Stainless Steel |

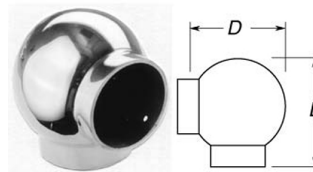

Ball Side Outlet Ell

| Part # | D | L | Finish |
|-----------|--------|--------|--------|
| LV703/112 | 2 1/2" | 2 3/4" | Brass |
| LV703/2 | 3 1/4" | 3 3/4" | Brass |

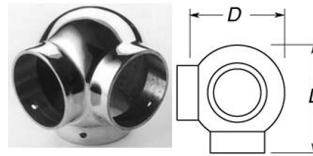

Ball Tee

| Part # | D | L | Finish |
|-----------|--------|--------|--------|
| LV704/112 | 2 1/2" | 3 3/4" | Brass |
| LV704/2 | 3 1/4" | 3 3/4" | Brass |

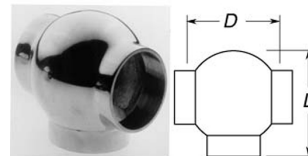

Flush Radius Ell

| Part # | W | H | Finish |
|-------------|--------|--------|-----------------|
| LV731/112 | 2 7/8" | 2 7/8" | Brass |
| LV731/112SS | 2 7/8" | 2 7/8" | Stainless Steel |
| LV731/2 | 3" | 3" | Brass |
| LV731/2-SS | 3" | 3" | Stainless Steel |

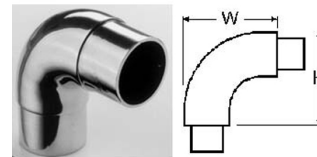

Flush 135 Degree Angle

| Part # | W | L |
|-----------|----------|--------|
| LV730/112 | 2 15/16" | 3" |
| LV730/2 | 2 7/8" | 3 1/2" |

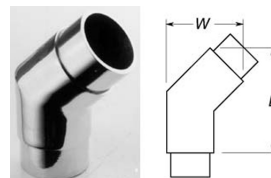

Lido-Weld

Structural adhesive which is a strong, fast, and reliable alternative to welding or soldering brass fittings and tubing. Can also be used to bond glass, ceramics, and thermoset plastics (such as laminate). 1.10 fl. oz. Sold per each.



| Part # | Description |
|------------|--------------------------|
| LVLB-00201 | Clear Adhesive |
| LVLB-00202 | Lido Luster polish cream |

Folding Shelf Bracket

Hinged Spring Brackets

Specially designed for extended tables and worktops. When tilted open, the spring bracket locks automatically. To close, lightly press the incorporated button. Hinged spring brackets are suitable for horizontal or verticals installation, screw mounted. Steel, yellow chromated finish. Sold per each, 2 per package.

HÄFELE



Horizontal Mount Application

66 lbs. per pair weight capacity. When raised, the spring-loaded bracket locks into position automatically.

| Part # | Size | Length | Width | Height |
|---------------|------|--------|-------|--------|
| FT65795 | 10" | 250mm | 85mm | 30mm |
| HA.287.41.915 | 15" | 380mm | 120mm | 30mm |

Folding L-Bracket

Features

- Adjustable to 4 positions: 90, 80, 70, and 0 degrees
- Supports up to 750 lbs. Per pair, when properly installed
- Durable steel construction with spring-loaded release lever



| Part # | Size |
|----------|------|
| KV206-12 | 12" |
| KV206-16 | 16" |

Table Apron Drop Leaf Supports

| | |
|-----------|----------------------------------|
| SYS557-06 | 6" open length (rivet to rivet) |
| SYS557-08 | 8" open length (rivet to rivet) |
| SYS557-10 | 10" open length (rivet to rivet) |
| SYS557-12 | 12" open length (rivet to rivet) |

Prime heavy gauge steel and spring loaded. Provide rigid support for raised leaves and for security. Prevents closing until spring tension is relieved by pulling on the release ring.

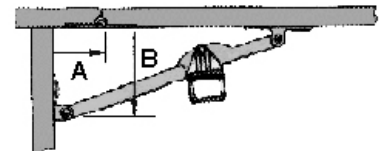

Maverick Hardware

Swing-up Fittings

Duo

- Two applications; lid or flap stay
- Can be mounted left or right
- Adjustable braking effect
- Lid/Flap stay clip mounts to brackets without tools
- Use of a magnet is recommended when used as a flap stay application

HÄFELE

| <u>Part #</u> | <u>Finish/Color</u> | <u>Version</u> |
|---------------|---------------------|------------------|
| HA373.66.660 | Nickel-plated | A (6 kg/13 lbs.) |
| HA373.66.661 | Nickel-plated | B (8kg/ 18 lbs.) |

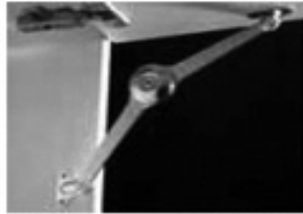

Wood Door Lid Stay



Aluminum Door Lid Stay



Flap Stay Doors

Cabinet Mounting Bracket

For attachment to side panel of cabinet

Material: steel

| <u>Part #</u> | <u>Finish/Color</u> | <u>Mounting distance from front edge</u> |
|---------------|---------------------|--|
| HA373.66.693 | Nickel-plated | 28mm (1 1/8") |
| HA373.66.694 | Nickel-plated | 37mm (1 7/16") |

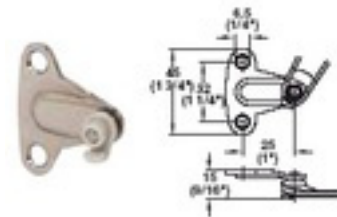

Door Mounting Bracket

For wood or aluminum frames over 35 mm (1 3/8") profile wide

Material: steel

| <u>Part #</u> | <u>Finish/Color</u> |
|---------------|---------------------|
| HA373.66.681 | Nickel-plated |

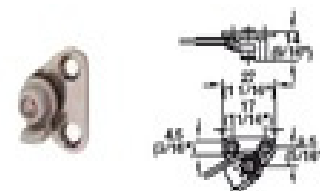

Door Mounting Bracket

For aluminum frames over 35 mm (1 3/8") profile wide

Material: steel

| <u>Part #</u> | <u>Finish/Color</u> |
|---------------|---------------------|
| HA373.66.682 | Nickel-plated |

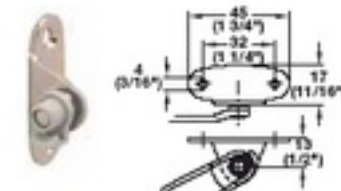

Special Door Mounting Bracket

For use with a face frame overlay 5-piece door

Material: steel

| <u>Part #</u> | <u>Finish/Color</u> |
|---------------|---------------------|
| HA373.66.685 | Nickel-plated |

Instructions

Swing-up Fittings

Duo

- Two stays are recommended for any door 600 mm (24") or wider
- Units may need to be re-adjusted after the first 300 cycles to maintain optimum performance; This is a one time adjustment that does not have to be repeated

Installation Version A

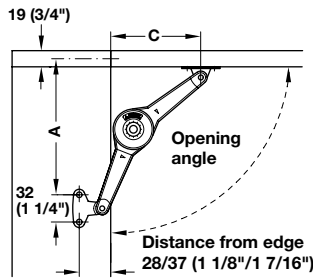

Installation Version B

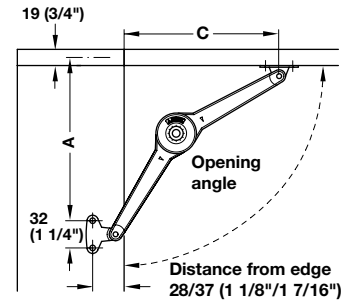

Lid Stay

| Opening Angle | Dimension A | Dimension C |
|---------------|---------------|----------------|
| 75° | 192 (7 9/16") | 148 (5 13/16") |
| 90° | 192 (7 9/16") | 106 (4 3/16") |
| 110° | 160 (6 5/16") | 108 (4 1/4") |

Lid Stay

| Opening Angle | Dimension A | Dimension C |
|---------------|----------------|---------------|
| 75° | 256 (10 1/16") | 212 (8 3/8") |
| 90° | 224 (8 13/16") | 182 (7 3/16") |
| 110° | 199 (7 13/16") | 154 (6 1/16") |

Version A

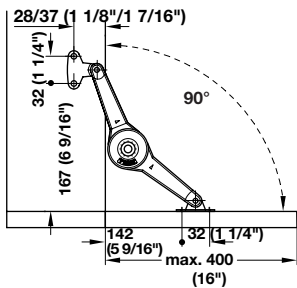

Version B

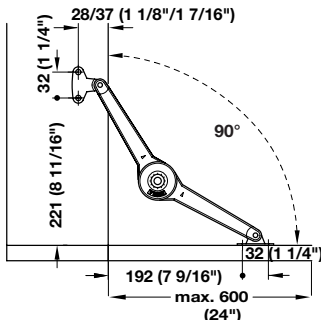

Version B

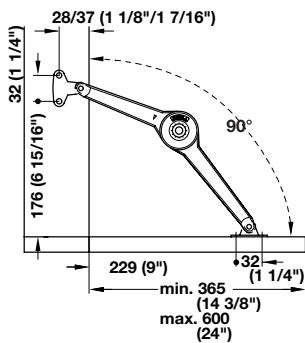

Hex Key, 4 mm

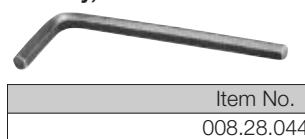

Item No.
008.28.044

*Packing: 2000 pcs.

Version A

Sample measurements table for max. flap weight

| Flap height inches | max. flap weight lbs. | | | |
|-------------------------------|-----------------------|-----------|------------------|-----------|
| | Stopping function | | Braking function | |
| | 1 Stay | 2 Stays | 1 Stay | 2 Stays |
| For opening angle 75° | | | | |
| 8" | 19.8 lbs. | 39.6 lbs. | 25.3 lbs. | 39.6 lbs. |
| 10" | 15.4 lbs. | 39.6 lbs. | 19.8 lbs. | 39.6 lbs. |
| 12" | 13.2 lbs. | 26.4 lbs. | 16.5 lbs. | 39.6 lbs. |
| 14" | 11 lbs. | 22 lbs. | 14.3 lbs. | 28.6 lbs. |
| 16" | 9.9 lbs. | 19.8 lbs. | 13.2 lbs. | 25.3 lbs. |
| 17 1/2" | 8.8 lbs. | 17.6 lbs. | 11 lbs. | 22 lbs. |
| 19 1/2" | 7.7 lbs. | 15.4 lbs. | 9.9 lbs. | 19.8 lbs. |
| For opening angle 90° | | | | |
| 8" | 16.5 lbs. | 39.6 lbs. | 20.9 lbs. | 39.6 lbs. |
| 10" | 13.2 lbs. | 26.4 lbs. | 16.5 lbs. | 39.6 lbs. |
| 12" | 11 lbs. | 22 lbs. | 13.2 lbs. | 28.6 lbs. |
| 14" | 8.8 lbs. | 18.7 lbs. | 12.1 lbs. | 24.2 lbs. |
| 16" | 7.7 lbs. | 15.4 lbs. | 11 lbs. | 22 lbs. |
| 17 1/2" | 7.7 lbs. | 14.3 lbs. | 8.8 lbs. | 18.7 lbs. |
| 19 1/2" | 6.6 lbs. | 13.2 lbs. | 8.8 lbs. | 17.6 lbs. |
| For opening angle 110° | | | | |
| 8" | 13.2 lbs. | 26.4 lbs. | 17.6 lbs. | 39.6 lbs. |
| 10" | 11 lbs. | 20.9 lbs. | 13.2 lbs. | 26.4 lbs. |
| 12" | 8.8 lbs. | 17.6 lbs. | 11 lbs. | 22 lbs. |
| 14" | 6.6 lbs. | 15.4 lbs. | 8.8 lbs. | 19.8 lbs. |
| 16" | 6.6 lbs. | 13.2 lbs. | 8.8 lbs. | 16.5 lbs. |
| 17 1/2" | 5.5 lbs. | 11 lbs. | 7.7 lbs. | 15.4 lbs. |
| 19 1/2" | 4.4 lbs. | 11 lbs. | 6.6 lbs. | 13.2 lbs. |

Version B

Sample measurements table for max. flap weight

| Flap height inches | max. flap weight lbs. | | | |
|-------------------------------|-----------------------|-----------|------------------|-----------|
| | Stopping function | | Braking function | |
| | 1 Stay | 2 Stays | 1 Stay | 2 Stays |
| For opening angle 75° | | | | |
| 8" | 30.8 lbs. | 39.6 lbs. | 39.6 lbs. | 39.6 lbs. |
| 10" | 25.3 lbs. | 39.6 lbs. | 39.6 lbs. | 39.6 lbs. |
| 12" | 19.8 lbs. | 39.6 lbs. | 26.4 lbs. | 39.6 lbs. |
| 14" | 17.6 lbs. | 39.6 lbs. | 24.2 lbs. | 39.6 lbs. |
| 16" | 15.4 lbs. | 30.8 lbs. | 19.8 lbs. | 39.6 lbs. |
| 17 1/2" | 13.2 lbs. | 27.5 lbs. | 17.6 lbs. | 39.6 lbs. |
| 19 1/2" | 12.1 lbs. | 24.2 lbs. | 15.4 lbs. | 39.6 lbs. |
| 21 1/2" | 11 lbs. | 22 lbs. | 14.3 lbs. | 28.6 lbs. |
| 23 1/2" | 11 lbs. | 20.9 lbs. | 13.2 lbs. | 26.4 lbs. |
| 25 1/2" | 8.8 lbs. | 18.7 lbs. | 12.1 lbs. | 24.2 lbs. |
| 27 1/2" | 8.8 lbs. | 17.6 lbs. | 11 lbs. | 23.1 lbs. |
| For opening angle 90° | | | | |
| 8" | 26.4 lbs. | 39.6 lbs. | 39.6 lbs. | 39.6 lbs. |
| 10" | 20.9 lbs. | 39.6 lbs. | 26.4 lbs. | 39.6 lbs. |
| 12" | 17.6 lbs. | 39.6 lbs. | 22 lbs. | 39.6 lbs. |
| 14" | 15.4 lbs. | 29.7 lbs. | 19.8 lbs. | 39.6 lbs. |
| 16" | 13.2 lbs. | 26.4 lbs. | 17.6 lbs. | 39.6 lbs. |
| 17 1/2" | 11 lbs. | 24.2 lbs. | 15.4 lbs. | 30.8 lbs. |
| 19 1/2" | 11 lbs. | 20.9 lbs. | 13.2 lbs. | 26.4 lbs. |
| 21 1/2" | 8.8 lbs. | 18.7 lbs. | 12.1 lbs. | 24.2 lbs. |
| 23 1/2" | 8.8 lbs. | 17.6 lbs. | 11 lbs. | 22 lbs. |
| 25 1/2" | 7.7 lbs. | 15.4 lbs. | 11 lbs. | 20.9 lbs. |
| 27 1/2" | 6.6 lbs. | 15.4 lbs. | 8.8 lbs. | 19.8 lbs. |
| For opening angle 110° | | | | |
| 8" | 20.9 lbs. | 39.6 lbs. | 27.5 lbs. | 39.6 lbs. |
| 10" | 16.5 lbs. | 39.6 lbs. | 22 lbs. | 39.6 lbs. |
| 12" | 14.3 lbs. | 27.5 lbs. | 17.6 lbs. | 39.6 lbs. |
| 14" | 12.1 lbs. | 24.2 lbs. | 15.4 lbs. | 30.8 lbs. |
| 16" | 9.9 lbs. | 20.9 lbs. | 13.2 lbs. | 27.5 lbs. |
| 17 1/2" | 8.8 lbs. | 18.7 lbs. | 12.1 lbs. | 24.2 lbs. |
| 19 1/2" | 8.8 lbs. | 16.5 lbs. | 11 lbs. | 22 lbs. |
| 21 1/2" | 7.7 lbs. | 15.4 lbs. | 8.8 lbs. | 19.8 lbs. |
| 23 1/2" | 6.6 lbs. | 13.2 lbs. | 8.8 lbs. | 17.6 lbs. |
| 25 1/2" | 6.6 lbs. | 12.1 lbs. | 8.8 lbs. | 16.5 lbs. |
| 27 1/2" | 6.6 lbs. | 11 lbs. | 7.7 lbs. | 15.4 lbs. |

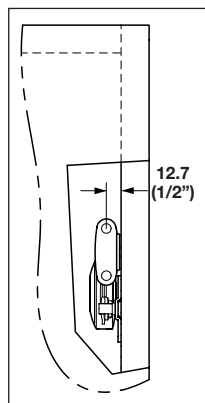

Door mounting bracket

Maverick Hardware

Lid Supports

90 Degree Support Hinge

Nickel plated steel. Specify size measured open 6" or 10" with locking notch. Made left and right handed. Sold per pair, 12 pair per box with screws.



| <u>Part #</u> | <u>Description</u> |
|---------------|--------------------|
| KV472-06 | 6" |
| KV472-10 | 10" |

Steel Friction Lid Supports



Straight Support

- Can be used to support drop lids of desks and cabinets
- Slotted slide action provides for smooth operation
- Reversible design allows for use in both right hand and left hand applications
- Overall length: 7 1/2"

| <u>Part #</u> | <u>Finish</u> |
|---------------|---------------|
| STH430 | Bright Brass |



Curved Support

- Use on storage containers where holding lid in open position is desired
- May be used on toy chests, tool boxes and other furniture items
- Bright brass

| <u>Part #</u> | <u>Description</u> |
|---------------|--------------------|
| STH444RH | Right Hand |
| STH444LH | Left Hand |

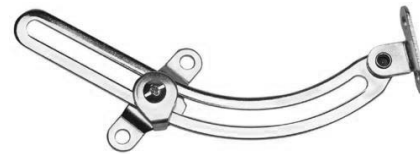

Chest/Box Lid Support

Allows smooth and east opening of lids, yet provides protection against slamming of lid. Designed for child's toy box, stereos, computers. Bronze plated steel. Packaged with screws. Mounts inside box. Order left and/or right hand hinges. Sold per each, 10 per box



| <u>Part #</u> | <u>Description</u> |
|---------------|--------------------|
| STH448 | Right Hand |
| STH449 | Left Hand |

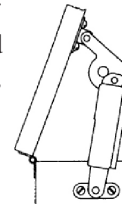

Stays

70/105 Degree Soft Up Stays

For use with upward-opening lids (ie., 70 degree- stereo cover, 105 degree- vanity with mirror). Use with piano, butt or concealed hinges. Made of zinc alloy and steel, with a bright nickel plated finish. Nickel plated wood screws included. Face plate included. Sold per each, 20 per box.



70 Degree Opening with Concealed Hinges Dimensions*

| Part # | Side | A | B(1) | C(1) | D(1) |
|-----------|-------|-----|------|-------|-------|
| SGNSD-20L | Left | 126 | 85-S | 101-S | 185-S |
| SGNSD-20R | Right | 126 | 85-S | 101-S | 185-S |

70 Degree Opening with Piano/Butt Hinges Dimensions**

| Part # | Side | A | B(1) | C(1) | D(1) |
|-----------|-------|-----|------|------|------|
| SGNSD-20L | Left | 125 | 84 | 100 | 184 |
| SGNSD-20R | Right | 125 | 84 | 100 | 184 |

105 Degree Opening with Concealed Hinges Dimensions*

| Part # | Side | A | B(1) | C(1) | D(1) |
|-----------|-------|-----|------|------|-------|
| SGNSD-20L | Left | 103 | 62-S | 78-S | 162-S |
| SGNSD-20R | Right | 103 | 62-S | 78-S | 162-S |

105 Degree Opening with Piano/Butt hinges Dimensions**

| Part # | Side | A | B(1) | C(1) | D(1) |
|-----------|-------|----|------|------|------|
| SGNSD-20L | Left | 97 | 56 | 72 | 156 |
| SGNSD-20R | Right | 97 | 56 | 72 | 156 |

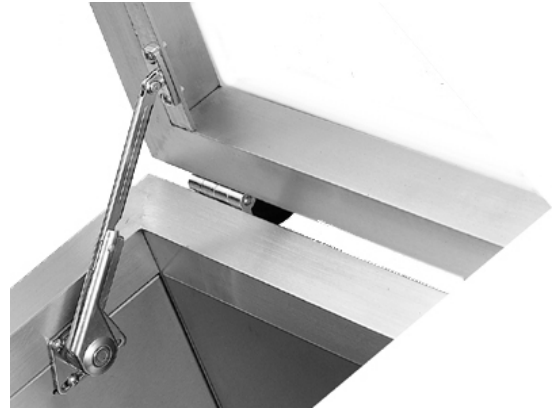

*Distance measured from the door edge to the inside of the backboard for use with European hinges

**Distance measured from the hinge center to the backside of the backboard for use with piano/butt hinges

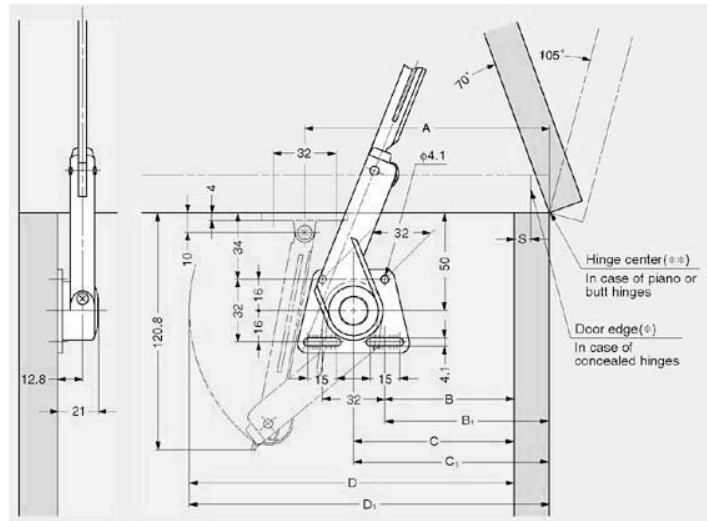

90 Degree Soft-Down Stay

With concealed hinges or single knuckle hinges

SGSDSC301N-WHT

ONE-WAY rotary clutch offers a smooth soft-down feature. Installation is quick and simple. Compact design makes the stays ideal for tight spaces. Open 90 degree for heavier duty (6.5 kg max. with two stays). For use with upward-opening flaps (upper kitchen cabinets). Supplied with screws (3.5 x 14). Recommended door thickness is 20 mm (25/32")

Torque moment formulas:

One SDS

Door height (cm) x 1/2 x Door weight (kg) 40 – 70 kg · cm

Two SDS

Door height (cm) x 1/2 x Door weight (kg) = 80 – 140 kg · cm

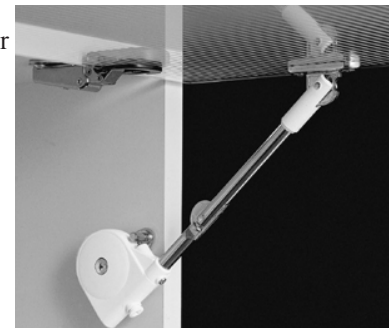

Maverick Hardware

Stays



90 Degree Down Stays

for use with downward-opening flaps (ie., bureaus, writing desks, and wine glass cabinets). Use with piano butt or drop hinges. Made of zinc alloy and steel, with a bright nickel-plated finish. Nickel-plated wood screws included. Face plate included. Sold per each.

| Part # | Side | Weight (g) |
|-----------|-------|------------|
| SGNSD-10L | Left | 210 |
| SGNSD-10R | Right | 210 |

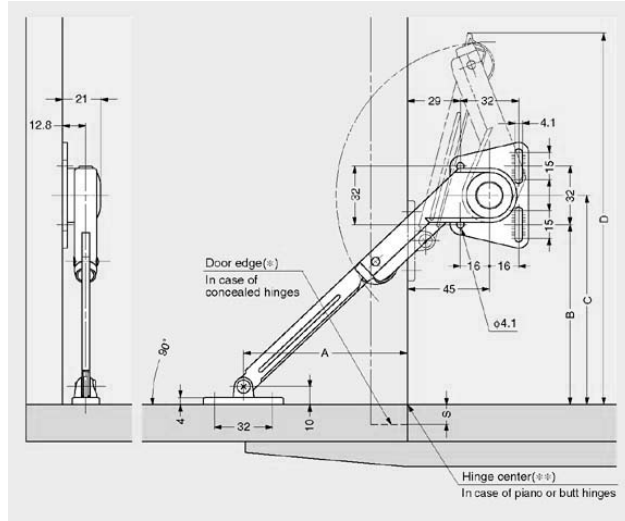

80/90/100 Degree Soft Up Stays

For use with upward-opening flaps (ie., upper kitchen cabinets). Use with piano, butt or concealed hinges. Made of zinc alloy and steel with a bright nickel-plated finish. Nickel-plated wood screws included. Face plate included. Sold per each, 20 per box. When 80 degree or 100 degree opening is desired, move the mounting plate and arm bracket by sliding them in the oblong adjustment slots provided.



90 Degree Opening with Concealed Hinge Dimensions*

| Part # | Side | A | B(1) | C(1) | D(1) |
|-----------|-------|----|------|-------|-------|
| SGNSD-35L | Left | 99 | 98-S | 114-S | 200-S |
| SGNSD-35R | Right | 99 | 98-S | 114-S | 200-S |

90 Degree Opening with Piano/Butt Hinge Dimensions**

| Part # | Side | A | B(1) | C(1) | D(1) |
|-----------|-------|----|------|------|------|
| SGNSD-35L | Left | 93 | 92 | 108 | 194 |
| SGNSD-35R | Right | 93 | 92 | 108 | 194 |

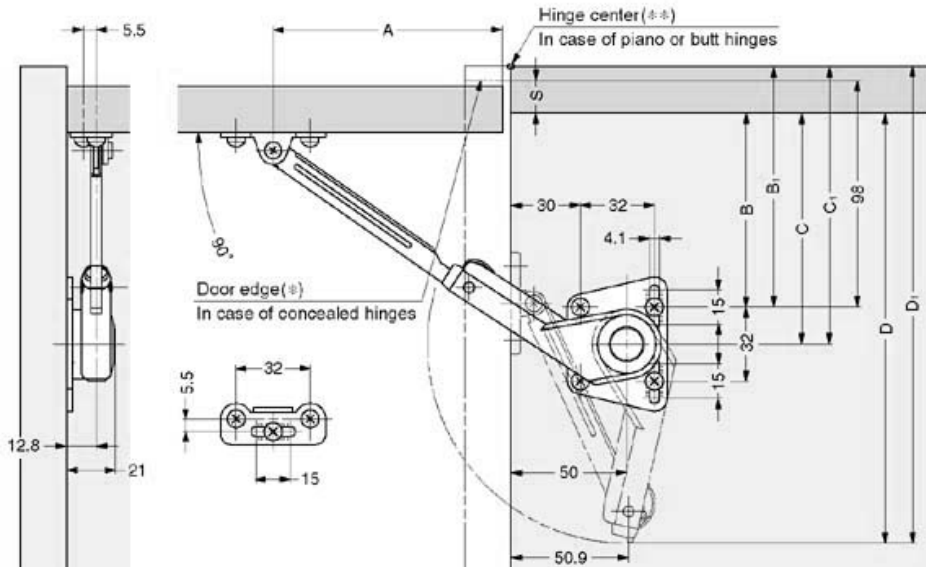
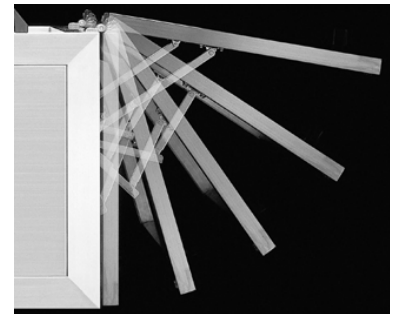

Stays

Arretop Lid Stay

HA373.70.639 Heavy-duty
 Includes an automatic lock. Can be installed left or right. Finish is steel, nickel-plated. Sold per each.

HÄFELE



Lid Stay

Positive stop to keep flap open. Left or right hand installation. 304 stainless steel, satin finish. 33 lbs. load per each. 10 pieces per box. Screws not included.

SUGATSUNE

| <u>Part #</u> | <u>Description</u> |
|---------------|------------------------|
| SGL195 | Max 90 Degree opening |
| SGL270 | Max 120 Degree opening |

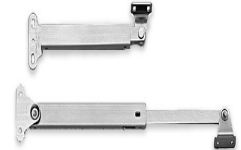

Hafele

Flap Stays, Stopmatic with Brake

HA365.74.722 250mm Flap Stay with Brake

Use in left or right hand installations; reverse position of foot and magnetic catch as needed. Keep brake piston rod free of oil, grease and other contaminants at all times.

HÄFELE



| <u>Length</u> | <u>Inside Cabinet Height</u> | <u>A</u> | <u>B</u> |
|---------------|------------------------------|----------|----------|
| 200 | 350 to 450 | 238 | 115 |
| 250 | 450 to 550 | 288 | 140 |
| 300 | 550 to 650 | 338 | 165 |

Flap Stay

HA365.75.710

Flap stay with catch, economy model with plastic housing; screw mounted. Can be installed left or right. Nickel plated and white plastic. Braking effect of the side panel mounting can be adjusted by loosening or tightening the adjusting screw on the stay. Must be mounted a minimum of 37mm from edge and 135mm from bottom of shelf. Sold per each.

HÄFELE



Lid Stay

The opened flap offers easy accessibility and optimum vision in the inside of the unit. The flap swings up automatically and is securely held in the open position. It is not necessary to raise the flap when closing. The flap remains reliably closed. Objects can still be placed on top of the unit. Quick mounting system on the flap and the holes of the side panel makes mounting easy. Can be installed right or left.

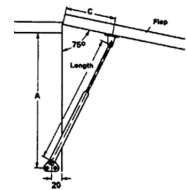

| <u>Part #</u> | <u>Material</u> | <u>Finish</u> | <u>Length</u> |
|---------------|-----------------|---------------|---------------|
| HA373.58.919 | Brass | Chrome | 250mm |
| HA373.58.811 | Brass | Polished | 250mm |

Maverick Hardware

Braces

Fasteners

KV324STL 3/4" Table Top Fastener

KV323STL 5/8" Table Top Fastener

Steel finish



Kolbe Korner

Mounting bracket for 5 piece shaker style drawer fronts. Allows for the drawer face to be mounted to the box easily, quickly and without wondering if you are going to drill through the drawer face.



Sold per box w/covers and screws

| Part # | Color |
|--------------|-------------|
| FCKK50BL | Black |
| FCKK.50PC.CM | Clear Maple |
| FCKK.50PC.LM | Light Maple |
| FCKK.50PC.WH | White |

| Part # | Color |
|-----------|-------------|
| FCKK500LM | Light Maple |
| FCKK500WH | White |

| Part # | Color |
|---------------------|-------------|
| FCKK.500PC.METAL.WH | White Metal |
| FCKK.50PC.METAL.TN | Tan |
| FCKK.50PC.METAL.WH | White |



Fasteners

Corner Brace



| Part # | Dimensions | Finish |
|--------|------------|--------|
| KV341 | 1" x 1" | Zinc |
| KV342 | 2" x 2" | Zinc |

| Part # | Color |
|-----------|-------------|
| FCKK500LM | Light Maple |
| FCKK500WH | White |

| Part # | Color |
|---------------------|-------------|
| FCKK.500PC.METAL.WH | White Metal |
| FCKK.50PC.METAL.TN | Tan |
| FCKK.50PC.METAL.WH | White |

Corner Braces

Zinc plated. Screws not included. Sold per each, 48 per box. (3" and 4" sold 24 per box").



| Part # | Length | Width |
|--------|--------|-------|
| PG9211 | 1" | 1/2" |
| PG9212 | 1 1/2" | 1/2" |
| PG9213 | 2" | 5/8" |
| PG9214 | 2 1/2" | 5/8" |
| PG9215 | 3" | 3/4" |

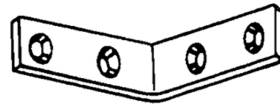

Mending Plates



| Part # | Description | Finish |
|--------|-------------|--------|
| PG9313 | 2" x 5/8" | Zinc |
| PG9315 | 3" x 3/4" | Zinc |

Desktop Fasteners

KV1547

12 gauge flat stamped wrought steel. Sold per each.



KV1548

18 gauge wrought formed steel. Sold per each.



Flat corner Iron



| Part # | Description | Finish |
|--------|----------------|--------|
| PG9413 | 2" x 2" x 3/8" | Zinc |

Glass & Grille Clip

EP2004

A quick, easy, inexpensive way to insert grilles and glass and still allow ease of removal for cleaning purposes. Steel construction, bronze finish. Sold per each, 100 per box.

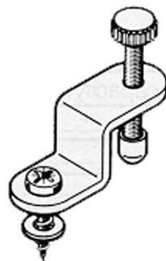

90° - 32mm Slotted Hole Angle Bracket



| Part # | Size | Finish |
|-----------|------------------|--------|
| PG9015-NI | 2" x 3/4" x 3/4" | Nickle |



Bumpers



Bumper Specialties

Features

- Molded, Self-Adhesive, 100% Polyurethane Bumpers
- Stocked in Clear only
- Custom shapes, sizes, colors and pad configurations are available for special order
- Clear bumpers are practically invisible when applied to colored or see through surface
- All bumpers available in aggressive synthetic rubber adhesive or high performance Acrylic Adhesive

Ideas for use

- Holds cutting boards firmly on in place on counter surface
- Keeps picture frames stable, preventing from damaging walls
- Dampens harsh sounds of slamming cabinet doors, drawers or lids
- Prevents speakers, electronics and computers for vibrating or sliding
- Quiet doorknobs, eliminating nicks and unsightly damage to walls

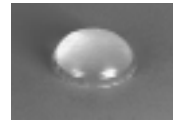

BS12SD

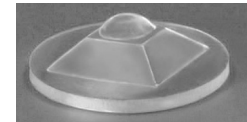

BS33SD



BS01SD



BS58SD



BS7

| <u>Part #</u> | <u>Description</u> | <u>Dimensions</u> |
|---------------|--------------------|---------------------|
| BS12SD | Dome Dumpers | .375 diam x .15 ht |
| BS1SD | Flat Bumper | .5 diam x .14 ht |
| BS33SD | Pyramid Shape | .5 diam x .15 ht |
| BS58SD | Cone Shape | .5 diam x .20 ht |
| BS7 | Simple | .335 diam x .085 ht |

Door Bumper Pads

Features

- 3/8" diameter x 3/32" thick
- White pads are 1/8" thick

| <u>Part #</u> | <u>Description</u> | <u>Size per roll</u> |
|---------------|----------------------|----------------------|
| DF38FBR-1M | Brown Felt | 1,000 |
| DF38FBR-5M | Brown Felt | 5,000 |
| DF38FWH-1M | White Felt | 1,000 |
| DFH38N-1M | Hex Natural Rubber | 1,000 |
| DFH38N-5M | Hex Natural Rubber | 5,000 |
| DFR38N-1M | Round Natural Rubber | 1,000 |
| DFR38N-5M | Round Natural Rubber | 5,000 |

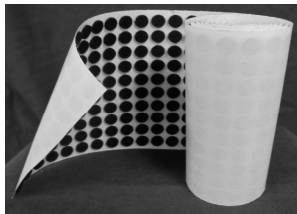

DF38FBR

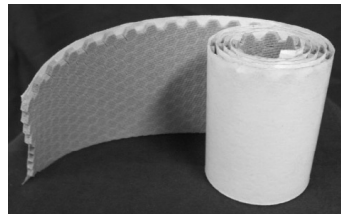

DFH38N

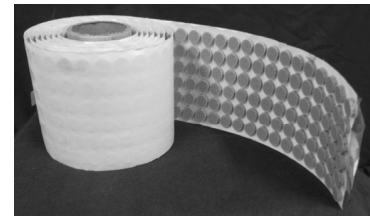

DFR38N

Binning Strips

Versatile plastic band strip can be installed on counters, tables, in drawers.

| <u>Part #</u> | <u>Description</u> | <u>Width</u> | <u>Color</u> |
|---------------|--------------------|--------------|--------------|
| OW282-BK | 60" binning strips | 2 3/4" | Black |
| OW282-WH | 60" binning strips | 2 3/4" | White |

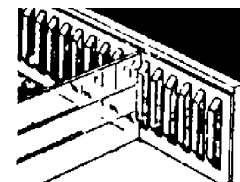

Break-Away Plastic Furniture Wedge

OWBREAK-A-WAY-WEDGE

Dark Brown

Wedges are used to assure proper positioning of furniture, doors and cabinets.



Maverick Hardware

Miscellaneous

Keku Push On Fittings

HA262.50.313 **Wood Screws – Frame/Panel Elements**

HA262.50.322 **Euro Screws – Frame Element**

Designed to allow panels to be directly mounted from the front. The panel component locks into the frame element as the panels are pushed together. The strong clamping effect is sufficient to hold even heavy panels securely, yet the fasteners can be quickly released again without any special tools. Frame side can be mounted in system holes with Euro screws or with #8 wood screws. Screws sold separately. Sold per pair.

HÄFELE



Keku Suspension Fitting

HA262.49.310 **Wood Screws**

Use for ceiling and wall coverings, panels and wainscoting, trim panels for built in cupboards and room dividers, and all types of cladding. Allows pre-assembly of sub-frames and fittings in the workshop. The fitting is comprised of two parts, a frame component and a panel component. The panel component is designed to lock onto the frame component lug on installation. All panels, once installed, can be easily removed at any time and with no special tools. Use #8 screws, sold separately. Both components are screw mounted. Sold per pair.

HÄFELE



Back Splash Fastener (Smart Clip)

DKCLIP

Used by leading universities, school systems, and approved by fine cabinet shops. Easy to install, waterproof and allows countertop form fitting to nearly any wall surface. It is installed in three easy steps: First, route the laminate backsplash. Second, install the screws into the bottom of the backsplash at 12" intervals. Then install the Smart Clips at 12" intervals on the countertop. Third, run a bead of caulk along the line of Smart Clips and drive the backsplash into position. Sold per set, screws and clips included.

THE SMART CLIP

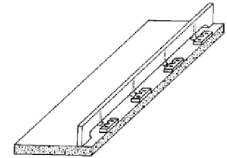

Accessories

- DKRB** **Smartclip router bit**
- DKSDG** **Smartclip screw depth gauge**
- DKSB** **Smartclip spacing bar**

Miscellaneous

Interlocking “Flushmounts”

SYK418-Z

A strong versatile hanger for wall panels, wall hung cabinets, mirrors, bed headboards displays. Two interchangeable interlocking pieces mate perfectly to provide secure fastening in only 1/8” thickness. Cold rolled .062 gauge steel, zinc plated, with four screw holes countersunk for #6 flat head screws. 1 1/2” wide x 1 3/4” high x 1/8” thick assembled.



Interlocking “Flushmounts”

SYK418MINI-Z

A strengthened shortened flushmount for horizontal stretches. Extra heavy, extra strong. Only 1/8” thick when assembled. .095 gauge steel with 2 holes countersunk for #6 flat head screws. 5/8” high x 1 9/16” wide x 1/8” thick assembled.

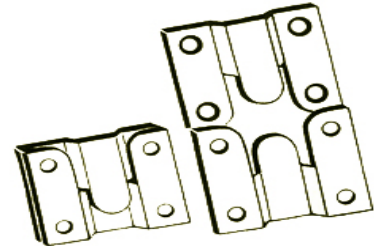

“Keyhole Fittings”

Used for assembling chairs, beds, cabinets etc. They fit on the ends of narrow timber in many varied applications. Screws engage through the keyholes and ride up the ramps under pressure providing powerful wedge action tightening.



SYK2093U Two Hole Jointing

3” long x 9/16” wide with three holes countersunk for #6 flat head screws. Keyholes clamp with #10 round head screws for rigid connections. .095 gauge cold rolled steel and zinc plated.

SYK2094U One Hole Jointing

1 5/8” long x 9/16” wide with two holes countersunk for #6 flat head screws. Keyholes provide rigid connection with #10 round head screws. .095 gauge cold rolled steel and zinc plated.

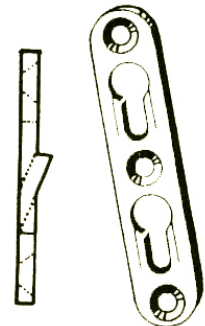

Brooklyn Hardware

Interlocking Panel Clips

A strong, versatile hanger for wall panels, wall hung cabinets, mirrors, bed headboards and displays. Two interchangeable interlocking pieces mate perfectly to provide secure fastening. Requires only 1/8” clearance. 1 1/2” wide x 1 3/4” high x 1/8” thick assembled dimensions. Four screw holes countersunk for #6 flat head screws. Screws sold separately. Cold rolled .062 gauge steel construction with zinc plated finish. Sold per set of two.

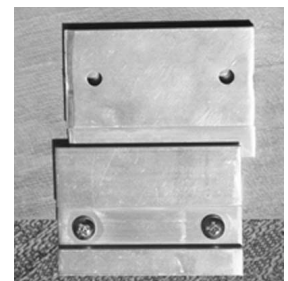

| <u>Part #</u> | <u>Description</u> |
|---------------|--------------------|
| PC-144 | 12” Panel Clip |
| PC-2.5 | 2.5” Panel Clips |

Maverick Hardware

Bed Fittings

Section J-3: Miscellaneous Hardware

Bed Rail Fastener

Rigid assembly for precision fit. Simple and easy dismount. Low cost. Screws sold separately. 1/8" steel. Use one set for four corner bed. Sold per set of 8 pieces.

| Part # | Description |
|--------------|---------------------|
| HA271.33.008 | 4" Bed Rail Bracket |
| HA271.33.090 | 5" Bed Rail Bracket |

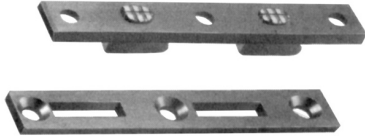

HÄFELE

Bed Rail Fastener

Rigid assembly for precision fit. Simple to install with quick and easy dismount. Low cost. Screws sold separately. 1/8" steel. Use one set for four corner bed. Sold per set of 8 pieces.

| Part # | Description |
|--------------|-------------------------|
| HA271.09.910 | 95mm Tommo Bed Fitting |
| HA271.09.930 | 120mm Tommo Bed Fitting |

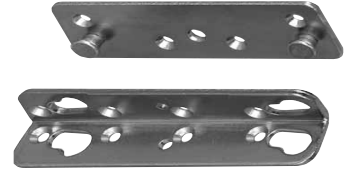

HÄFELE

Bed Fitting

Bed Connecting Bracket, screw-mounted

- Left or right use
- Hook-type fastening
- Sturdy design

Material: steel, unfinished

| Part # | Description |
|--------------|-------------------|
| HA271.05.004 | 95mm Bed Fitting |
| HA271.05.013 | 145mm Bed Fitting |

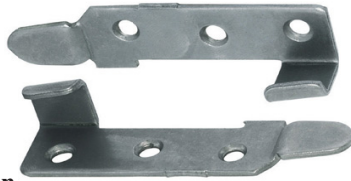

HÄFELE

Bed Fitting

| Part # | Description |
|--------------|-------------|
| HA271.19.946 | 127mm |



HÄFELE

Miscellaneous

**Swivel Hub Series
 SYXSWIVELROL2**

Nylon roller mounted on a steel base for screw attachment. For #6 screws on 32mm hole spacing.



Colonial Saw

Lamello Wood Joining Biscuits

Joining plates of beech wood, carefully pressed, free of dust and fibers, high tensile strength, fine ground edges. USES: for joining surfaces, ceilings, frames; butt jointed, offset or mitered; for particle boards, solid wood and plywood.

| Part # | Size of Biscuits | Quantity |
|--------|-------------------|-----------|
| LBC-0 | #0 47 x 15 x 4mm | 100/bag |
| LBC-9 | #9 38 x 12 x 3mm | 100/bag |
| LBC-10 | #10 53 x 19 x 4mm | 100/bag |
| LBC-20 | #20 56 x 23 x 4mm | 100/bag |
| LBM-0 | #0 47 x 15 x 4mm | 1,000/box |
| LBM-9 | #9 38 x 12 x 3mm | 1,000/box |
| LBM-10 | #10 53 x 19 x 4mm | 1,000/box |
| LBM-20 | #20 56 x 23 x 4mm | 1,000/box |



**Folding Leg Fitting
 SYS149L**

For long extension tables where it is necessary to provide additional support legs. Folds up underneath when not in use. Spring activated trigger release provides positive locking in both open and closed positions. Accomodates 1 1/2" square leg without cutting or shaping. Steel, bronze plated, unhanded.

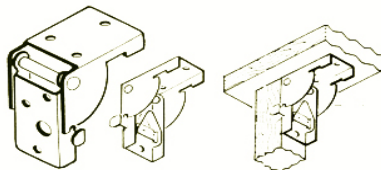

Threaded Sleeve 5mm

Perfect for connecting two panels together. Use with 5mm diameter hole. Pozidrive head. Nickel plated finish. Sleeve and bolt sold separately. 5/8" includes sleeve only. 3/4" includes sleeve and screw.

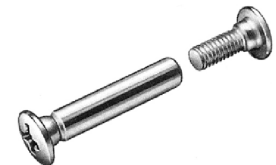

Space Balls

Center solid panels. Stops panel rattle. Compresses if panels expand. Helps eliminate cracking glue joints. They fit standard stile and rail cutters. 8 -10 Spaceballs recommended per door. 1000 per bag.

| Part # | Diameter | Quantity |
|-----------|----------|----------|
| YY-SB-1M | .26 | 1000 |
| YY-SB-5M | .26 | 5000 |
| YY-SB1-1M | .21 | 1000 |



| Part # | Description |
|------------|-----------------------------------|
| FT23749307 | 16mm Panel Connector |
| FT23749407 | 19mm Panel Connector |
| FT26049507 | Connecting screw for metal sleeve |

Maverick Hardware

Table Hardware

Round Table Catch

Screw-mounts to underside of table top to join panels together

Material: brass

| <u>Part #</u> | <u>Size</u> |
|---------------|-------------|
| HA642.39.818 | Small |
| HA642.39.827 | Large |

* Small is special order only

HÄFELE



Table Fork

Attaches underneath table top to join two separate sections firmly together

Material: brass

| <u>Part #</u> |
|---------------|
| HA642.38.802 |

HÄFELE



Peg and Sleeve Connector

Presses into holes 8mm

Material: steel

| <u>Part #</u> | <u>Finish</u> |
|---------------|------------------|
| HA642.51.243 | yellow chromated |

HÄFELE



Swivel Bolt

Recess or screw-mounts underneath the table top to join the leaves

Material: steel

| <u>Part #</u> | <u>Finish</u> |
|---------------|---------------|
| HA642.48.920 | zinc-plated |

HÄFELE



Spring Clips

Screw-mounts underneath the table top

Material: steel

| <u>Part #</u> | <u>Finish</u> |
|---------------|---------------|
| HA380.52.925 | zinc-plated |

HÄFELE



Folding Table Hinges-Recessed

Material: steel, Color: yellow chromated

| <u>Part #</u> | <u>Hinge size</u> <u>length x width</u> | <u>Recess</u> <u>Depth</u> | <u>Table</u> <u>Top</u> |
|---------------|--|-------------------------------|----------------------------|
| HA341.30.508 | 85 x 47 | 16 | 19 |
| HA341.30.526 | 85 x 51 | 19 | 20 |

HÄFELE

